

Rheonics SRD-X7-RP450	
Material	316L
Connection Process	Custom Compression Fitting

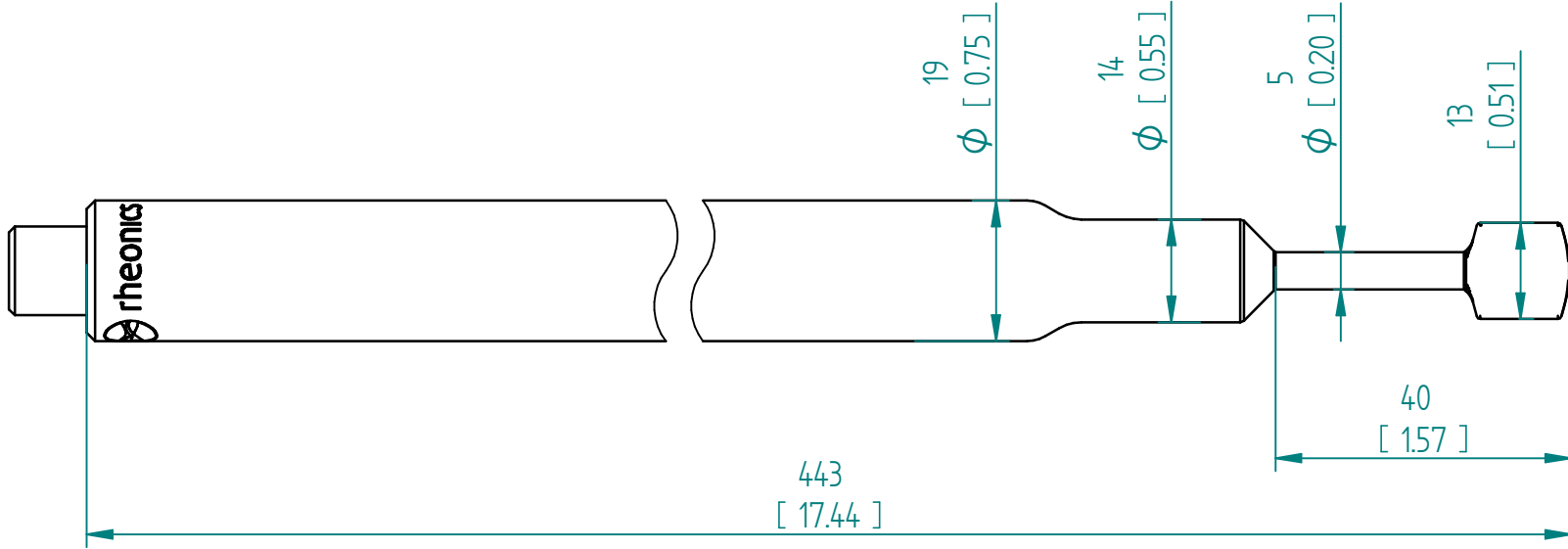

Units: mm
[inch]

SRD-X7-RP450 Reactor Probe

This drawing remains property of rheonics. It may be neither copied nor informed to third persons or competitors without our approval. (2 paragraph 1 fig.7 copyright act of 9th Sept. 1965)



Protected by US and International patents granted and pending

rheonics • Switzerland • USA • www.rheonics.com • info@rheonics.com +41 52 511 32 00 +1 713 364 5427

Release: 2311