

# rheonics



inline process  
density and viscosity  
monitoring

**HART<sup>®</sup> Field Device Specification:**  
Rheonics, SME



*Covers sensor Types:* **SR (SRV, SRD)**  
**DV (DVP, DVM)**

## **GLOBAL SUPPORT**

**For Support, visit: <https://support.rheonics.com>**

### **EUROPE HEADQUARTERS**

Rheonics GmbH  
Klosterstrasse. 19  
8406 Winterthur Switzerland  
Tel: +41 52 511 32 00

### **US HEADQUARTERS**

Rheonics, Inc.  
3 Sugar Creek Center Blvd, Ste 100  
Sugar Land, TX 77478  
United States of America  
Tel: +1 713 364 5427

Website: <https://rheonics.com>  
Support Portal: <https://support.rheonics.com>  
Sales E-Mail: [info@rheonics.com](mailto:info@rheonics.com)  
Support E-Mail: [support@rheonics.com](mailto:support@rheonics.com)

### **© COPYRIGHT RHEONICS 2022**

No part of this publication may be copied or distributed, transmitted, transcribed, stored in a retrieval system, or translated into any human or computer language, in any form or by any means, electronic, mechanical, manual, or otherwise, or disclosed to third parties without the express written permission of Rheonics. The information contained in this manual is subject to change without notice.

### **TRADEMARKS**

Rheonics is a trademark of Rheonics, Inc. Other product and company names listed in this manual are trademarks or trade names of their respective manufacturers.

## Contents

<b>1</b>	<b>Before you begin</b> .....	<b>4</b>
<b>2</b>	<b>Product overview</b> .....	<b>5</b>
<b>3</b>	<b>Product interfaces</b> .....	<b>14</b>
<b>4</b>	<b>Sensor Status</b> .....	<b>23</b>
<b>5</b>	<b>Troubleshooting</b> .....	<b>25</b>
<b>6</b>	<b>Appendix A: PACTWARE DC software</b> .....	<b>27</b>
<b>7</b>	<b>Appendix B: HARTmpt</b> .....	<b>28</b>
<b>8</b>	<b>Notes/Errata</b> .....	<b>29</b>

# 1 Before you begin

## 1.1 About the manual

This manual provides information on HART Protocol Revision 1.0. This document specifies all the device-specific features and documents HART Protocol implementation details (e.g., the Engineering Unit Codes supported and output variables).

Important

This manual assumes that the following conditions apply:

- The sensor has been installed correctly and completely according to the installation instructions.
- The installation complies with all applicable safety requirements.
- The user is trained in government and corporate safety standards.

## 1.2 Purpose

This specification is designed to complement the SME Installation Manual by providing a complete, unambiguous description of this Field Device for use in HART Communication networks.

## 1.3 Who should use this document?

The specification is designed to be a technical reference for HART End Users. This document assumes the reader is familiar with HART Protocol requirements and terminology.

## 1.4 Warning

Before connecting the HART Communicator in an explosive atmosphere, make sure instruments in the loop are installed in accordance with intrinsically safe or nonincendiary field wiring practices. To connect a HART communicator, use the CH1 from the SME.

## 1.5 Caution

For the HART Communicator to function properly, a minimum of 250 ohms of resistance must be present in the loop. The communicator does not directly measure loop current.

Abbreviation (short form)	Full-term	Meaning
SRV	Symmetric Resonator Viscometer	Viscosity sensor
SRD	Symmetric Resonator Densitometer	Density and Viscosity sensor
DVP	Density Viscosity Probe	HPHT inline probe
DVM	Density Viscosity Module	HPHT inline module
RCP	Rheonics Control Panel	Software for data acquisition and configuration
SME	Smart Module Electronics	Sensor electronics

Table 1. Nomenclature for Rheonics devices

## 1.6 Related Documentation

You can find all product documentation on the USB stick shipped with the SME and on our website at <https://rheonics.com/resources>

## 2 Product overview

The Rheonics SME provides clients HART interface to get digital data over the traditional 4-20 mA channel. This document provides guidance for field connection by an end user.

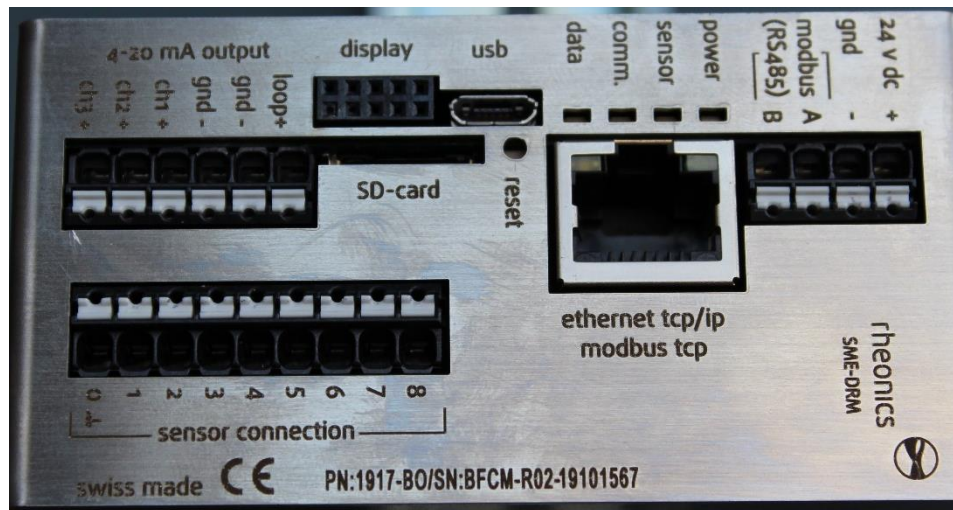

Figure 1. SME sensor electronics unit.

### 2.1 Process Interface

The SME is compatible with various Rheonics modules find below the ones that are compatibles.



Figure 2. Rheonics Sensor for Viscosity and density measurements.

### 2.2 HART operating principle

HART stands for **H**ighway **A**ddressable **R**emote **T**ransducer. It allows two-way analog communication between smart-process instruments and host systems for controlling and monitoring. HART communication is a digital data communication that use the same wiring as the analog output of 4-20mA, this is achieved by encoding the signal over the analog communication.

### 2.3 Variables running in the SME

For HART communication, Rheonics provides the following variables (PV, SV, TV, and QV) over Channel 1 analog output 4-20mA.

Primary Variable (PV)	Density	g/cc
Secondary Variable (SV)	Viscosity	cP
Tertiary Variable (TV)	Temperature	°C
Quaternary Variable (QV)	Sensor Status	

Table 2. Variable list for Rheonics Sensor

## 2.4 HART commands

The HART Command Set enables uniform and consistent control of all field devices. The command set consists of three classes: Universal, Common Practice, and Device Specific. Sections below describe the commands currently available for Rheonics HART sensors and some examples of responses.

## 2.5 HART Universal commands

**2.5.1 Command 0 Read: Unique Identifier:** Return identity information about the field device including the Device Type, Revision Levels, and Device ID. This command is implemented by a field device in both Short and Long Frame Formats. Command 0 is the only command that may respond to a short frame address.

Request Data bytes

Index	Type	Description
None		

Response Data bytes

Index	Type	Description
0	Unsigned-8	Reserved. Constant value "254"
1-2	Enum	Device Type Code
3	Unsigned-8	Minimum Number of Preambles required (Master to Slave)
4	Unsigned-8	HART Protocol Major Revision
5	Unsigned-8	Device Revision Level
6	Unsigned-8	Software Revision Level
7	Unsigned-8	Hardware Revision
8	Bits	HART Signal Flags
9-11	Unsigned-24	Device ID
12	Unsigned-8	Minimum Number of preambles (Slave to Master)
13	Unsigned-8	Maximum Number of Device Variables
14-15	Unsigned-16	Configuration Change Counter
16	Bits	Extended Field Device Status
17-18	Enum	Manufacturer - Identification Code -615D
19-20	Enum	Private Label Distributor - Identification Code
21	Enum	Device Profile Code

Command specific response codes

Code	Class	Description
------	-------	-------------

0	Success	No Command-Specific Error
---	---------	---------------------------

**Transmitter Information**

Polling:

Message:

Description:

Tag:

Date:  /  /

Assembly:

Alarm Type:

Write Protect:

Vendor ID:

---

**Identification**

Manufacturer:

Type:

Device ID:

Unique ID:

**Revision**

Universal:

Device:

Hardware:

Software:

Figure 3. Command 0: Unique identifier response with HARTmpt software.

### 2.5.2 Command 1 Read: Primary Variable: The Primary Variable value is returned along with its Units Code.

Request Data bytes

Index	Type	Description
None		

Response Data bytes

Index	Type	Description
0	Enum	Primary Variable - Unit Code
1-4	Float	Primary Variable - Value

Command specific response codes

Code	Class	Description
0	Success	No Command-Specific Error
6	Error	Device-Specific Error
8	Warning	Update Failure
16	Error	Access Restricted

- Example:

**Output**

PV	1.000	g/cm3
SV	0.000	cP
Current	9.333	mA
Percent	33.333	%

Figure 4. Command 1 Read: Primary Variable response with HARTmpt software.

### 2.5.3

**Command 2 Read: Current Loop, Percent of Range:** Reads the Loop Current and its associated Percent of Range. The Loop Current always matches the current that can be measured by an ammeter in series with the field device; this includes the loop current under alarm conditions.

Request Data bytes

Index	Type	Description
None		

Response Data bytes

Index	Type	Description
0-3	Float	Primary Variable - Loop Current [mA]
4-7	Float	Primary Variable - Percent Of Range [%]

Command specific response codes

Code	Class	Description
0	Success	No Command-Specific Error
6	Error	Device-Specific Error
8	Warning	Update Failure
16	Error	Access Restricted

- Example:

**Monitor**

PV	1.000000	g/cm3	SV	0.000000	cpoise
Current	14.666667	mA	TV	27.728001	°C
Percent	66.666672	%	QV	512.000000	none
Cold Temp	0.000000	°C			

Figure 5. Command 2 Read: Current Loop, Percent of Range response with HARTmpt software.



**2.5.4 Command 3 Read: Dynamic Variable, Loop Current:** Reads the Loop Current and up to four predefined Dynamic Variables. The Loop Current always matches the current that can be measured by an ammeter in series with the field device; this includes alarm conditions and set values.

Request Data bytes

Index	Type	Description
None		

Response Data bytes

Index	Type	Description
0-3	Float	Primary Variable - Loop Current [mA]
4	Enum	Primary Variable - Unit Code
5-8	Float	Primary Variable - Value
9	Enum	Secondary Variable - Unit Code
10-13	Float	Secondary Variable - Value
14	Enum	Tertiary Variable - Unit Code
15-18	Float	Tertiary Variable - Value
19	Enum	Quaternary Variable - Unit Code
20-23	Float	Quaternary Variable - Value

Command specific response codes

Code	Class	Description
0	Success	No Command-Specific Error
6	Error	Device-Specific Error
8	Warning	Update Failure
16	Error	Access Restricted

**2.5.5 Command 7 Read Loop Configuration:** Read Polling Address and the Loop Current Mode.

Request Data bytes

Index	Type	Description
None		

Response Data bytes

Index	Type	Description
0	Unsigned-8	Polling Address
1	Enum	Loop Current Mode

Command specific response codes

Code	Class	Description
0	Success	No Command-Specific Error
16	Error	Access Restricted

**2.5.6 Command 8 Read: Dynamic Variable Classification:** Reads the Classification Associated with the Dynamic Variables. The Classification determines the Unit Code Expansion Table that must be used by a Host.

Request Data bytes

Index	Type	Description
None		

Response Data bytes

Index	Type	Description
0	Enum	Primary Variable Classification
1	Enum	Secondary Variable Classification
2	Enum	Tertiary Variable Classification
3	Enum	Quaternary Variable Classification

Command specific response codes

Code	Class	Description
0	Success	No Command-Specific Error
16	Error	Access Restricted

**2.5.7 Command 11 Read: Unique Identifier Associated with Tag:** This command may be issued using either the device's long frame address or the Broadcast Address. No response is made unless the Tag matches that of the device. When the device's long frame address is used, no response is made unless the address and Tag match that of the device.

Request Data bytes

Index	Type	Description
0-5	Packed	Device Tag (6 Byte as 8-character Packed ASCII)

Response Data bytes

Index	Type	Description
0	Unsigned-8	Reserved. Constant value "254"
1-2	Enum	Device Type Code
3	Unsigned-8	Minimum Number of Preambles required (Master to Slave)
4	Unsigned-8	HART Protocol Major Revision
5	Unsigned-8	Device Revision Level
6	Unsigned-8	Software Revision Level
7	Unsigned-8	Hardware Revision
8	Bits	HART Signal Flags
9-11	Unsigned-24	Device ID
12	Unsigned-8	Minimum Number of preambles (Slave to Master)
13	Unsigned-8	Maximum Number of Device Variables
14-15	Unsigned-16	Configuration Change Counter

16	Bits	Extended Field Device Status
17-18	Enum	Manufacturer - Identification Code
19-20	Enum	Private Label Distributor - Identification Code
21	Enum	Device Profile Code

Command specific response codes

Code	Class	Description
0	Success	No Command-Specific Error

### 2.5.8 **Command 12 Read: Message:** Reads the Message contained within the device.

Request Data bytes

Index	Type	Description
None		

Response Data bytes

Index	Type	Description
0-23	Packed	Device Message (24 Byte as 32 characters Packed ASCII)

Command specific response codes

Code	Class	Description
0	Success	No Command-Specific Error
16	Error	Access Restricted
32	Error	Busy

### 2.5.9 **Command 13 Read: Device Tag, Descriptor, Date** Read the Tag, Descriptor, and Date contained within the device. Only the Tag (6 Bytes or 8 Packed ASCII characters) is read here. To use the Long Tag used to command 20.

Request Data bytes

Index	Type	Description
None		

Response Data bytes

Index	Type	Description
0-5	Packed	Device Tag (6 Byte as 8 characters Packed ASCII)
6-17	Packed	Descriptor (12 Byte as 16 characters Packed ASCII)
18-20	Date	Date of next/last device action

Command specific response codes

Code	Class	Description
0	Success	No Command-Specific Error
16	Error	Access Restricted
32	Error	Busy

The “Descriptor” message showcases the sensor serial number and sensor type

2.5.10 **Command 15 Read: Device Information:** Reads the Alarm Selection Code, Transfer Function Code, Range Values Unit Codes, Upper/Lower Range Values, Damping Value, and Write Protect Code.

Request Data bytes

Index	Type	Description
None		

Response Data bytes

Index	Type	Description
0	Enum	Primary Variable - Alarm Selection Code
1	Enum	Primary Variable - Transfer Function Code
2	Enum	Primary Variable - Upper/Lower Range Unit Code
3-6	Float	Primary Variable - Upper Range Value
7-10	Float	Primary Variable - Lower Range Value
11-14	Float	Primary Variable - Damping Value [s]
15	Enum	Write Protection Code
16	Enum	Reserved
17	Bits	Primary Variable - Analog Channel Flag

Command specific response codes

Code	Class	Description
0	Success	No Command-Specific Error
16	Error	Access Restricted
32	Error	Busy

2.5.11 **Command 20 Read: Device Long Tag:** Reads the 32 Byte Long Tag. Only the Long Tag (32 ISO Latin-1 characters) is read here.

Request Data bytes

Index	Type	Description
None		

Response Data bytes

Index	Type	Description
0-31	Latin-1	Long Tag (32 Byte - Latin-1)

Command specific response codes

Code	Class	Description
0	Success	No Command-Specific Error
16	Error	Access Restricted
32	Error	Busy

## 2.6 HART specific commands

### 2.6.1 Command 128-Write SRV density

This command is available in HART-7 (only), it accepts 6 Float values which are the Do0 to

Do5(Coefficients from a temperature compensated density). Refer to section **3.4 Device Specific HART commands**

Request Data Bytes

Bytes	Format	Data
0-3	Float	Do0
4-7	Float	Do1
8-11	Float	Do2
12-15	Float	Do3
16-19	Float	Do4
20-23	Float	Do5

Response data bytes

Same as request data bytes.
-----------------------------

Command specific response codes

Code	Class	Description
0	Success	Command accepted, does not guarantee that data will be accepted by the sensor
5	Error	Command frames too short
7	Error	The device is not an SRV and thus does not accept density parameters
64	Error	Command not implemented (it's only available in HART-7)

## 2.6.2 Command 129-Read SRV density

This command is available in HART-7 (only), it accepts 6 Float values which are the Do0 to Do5(Coefficients from a temperature compensated density)

Request Data Bytes

There are no request data bytes
---------------------------------

Response data bytes

See response from the status from each coefficient from density
---

Command specific response codes

There are not command specific responses
--

## 3 Product interfaces

### 3.1 Components used for each test

- Rheonics SRV, SRD, DVP or DVM w/ Firmware V03.30/0 or higher
- HART modem
- HART data communication software
- Software sensor: Rheonics Control Panel (RCP)
- Windows 10 64 bit

### 3.2 HART Modem

The HART Communicator provides a common communication link to all HART-compatible, microprocessor-based instruments. When starting the device, the communicator is automatically searching for the HART signal and displays the results. (See Appendix A: HART modem)

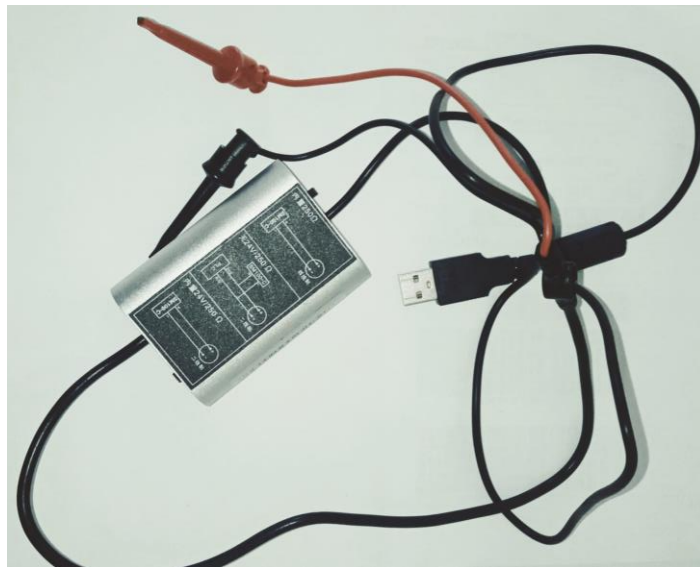

Figure 6. HART Modem SM100-C(III).

### 3.3 Connection with PACTWARE DC software

PACTware is a manufacturer and Fieldbus-independent software application for easy operation of automation field devices. (See Appendix B: PACTware DC software)

- 3.3.1 Open PACTware DC 5.0
- 3.3.2 Click on Device button.

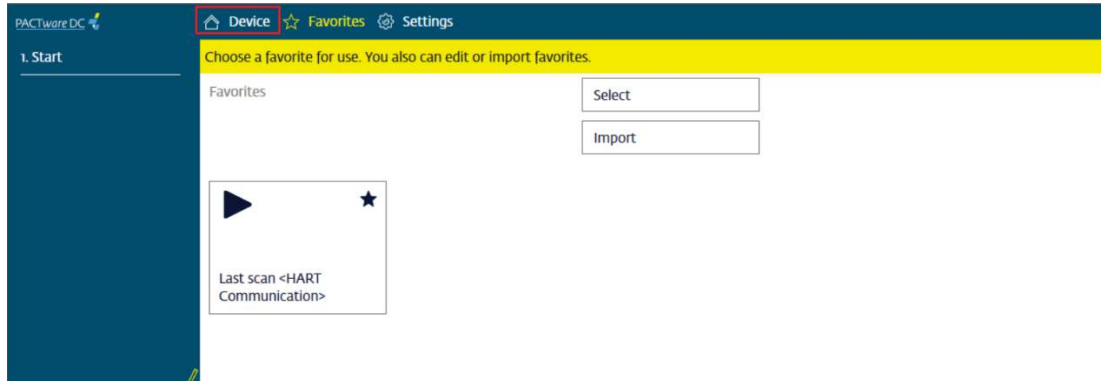

Figure 7. Open the Device tab.

- 3.3.3 Search new device.

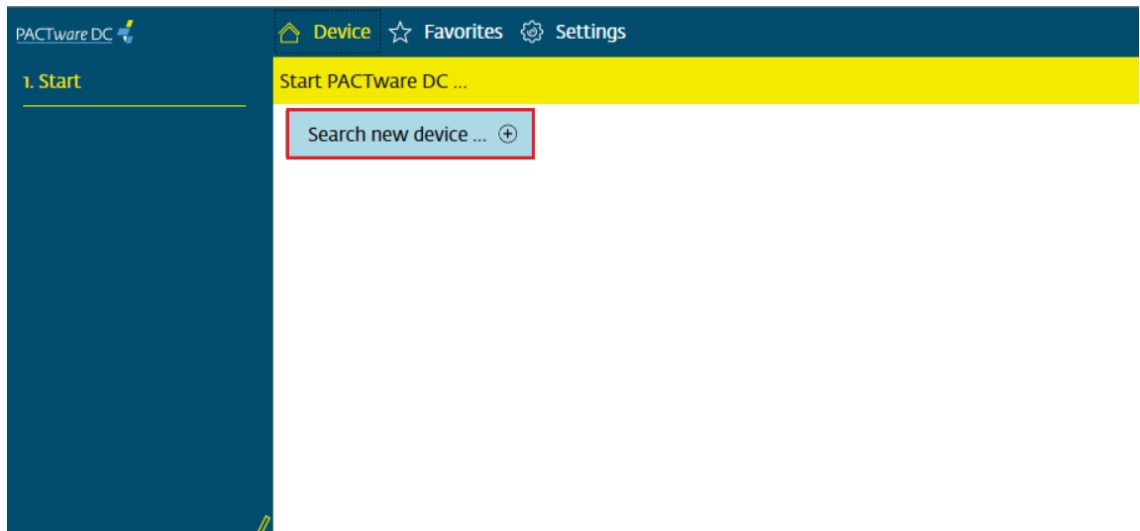

Figure 8. Search new device.

### 3.3.4 Select HART communication.

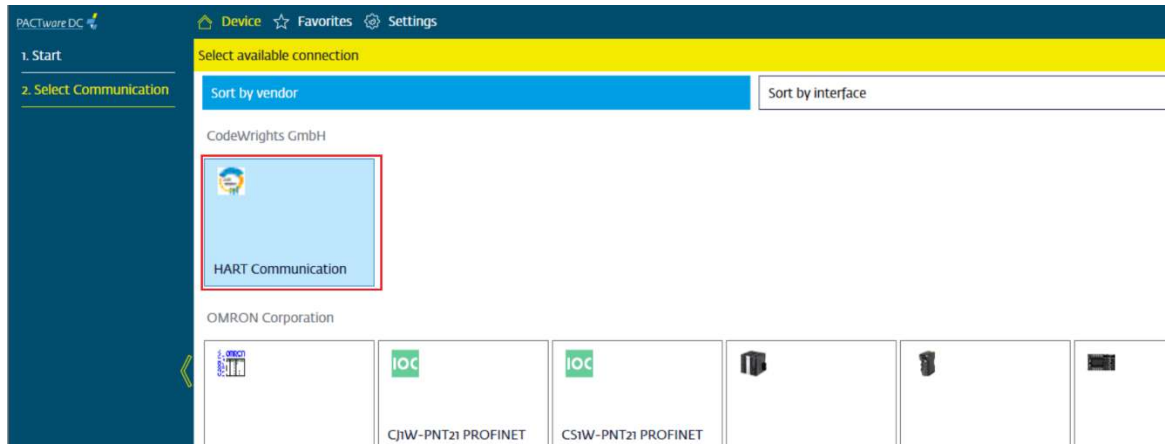

Figure 9. Select Hart communication.

### 3.3.5 Select HART modem communication port and then click ok.

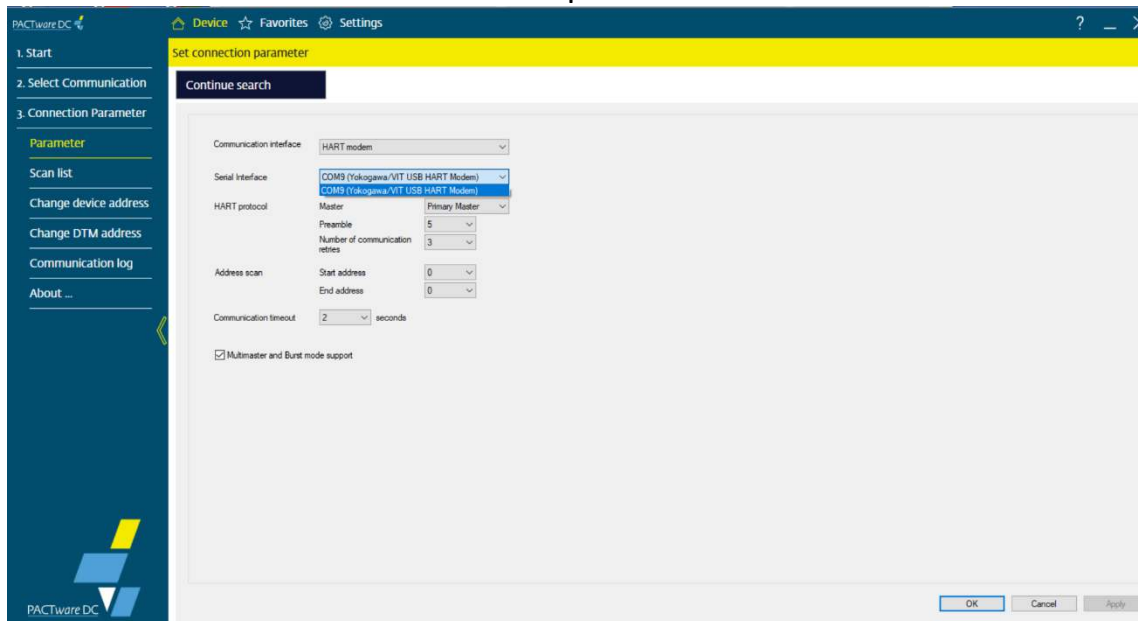

Figure 10. Selecting Serial interface.



### 3.3.6 Select the Measured Values Display option from the Device Menu

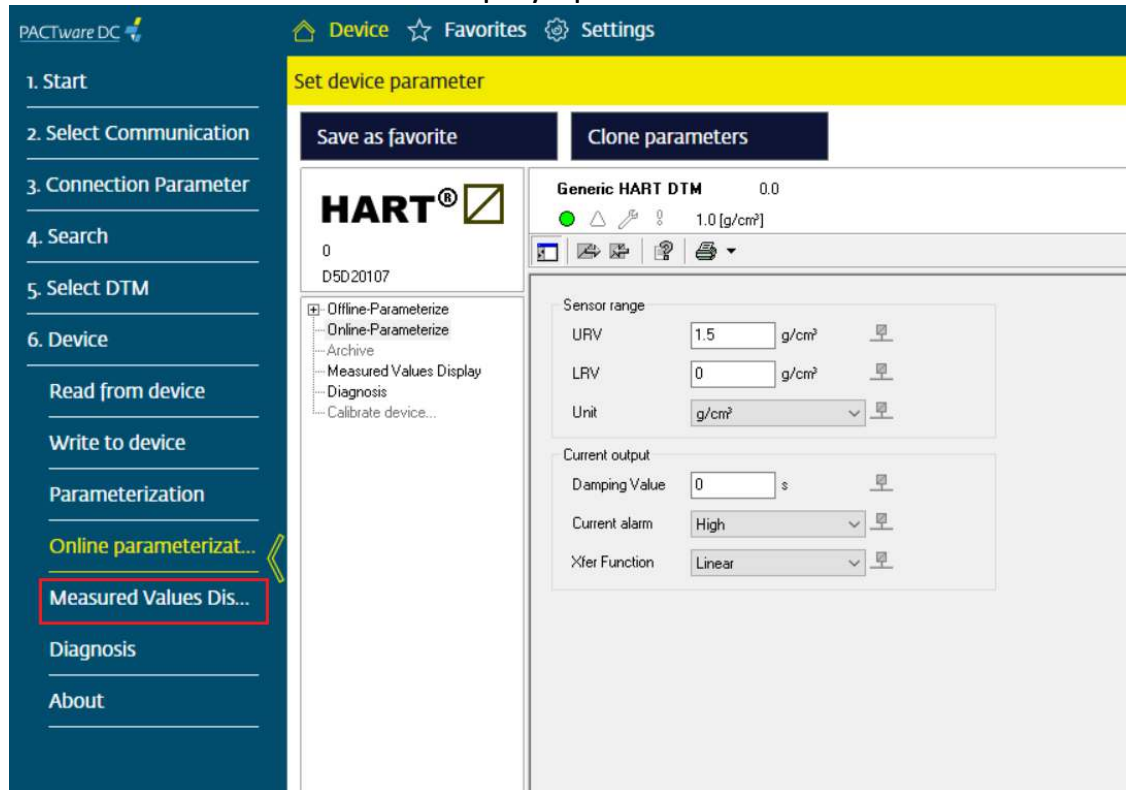

Figure 11. Select the correct option from the Device Menu.

### 3.3.7 Read parameters from the SME device

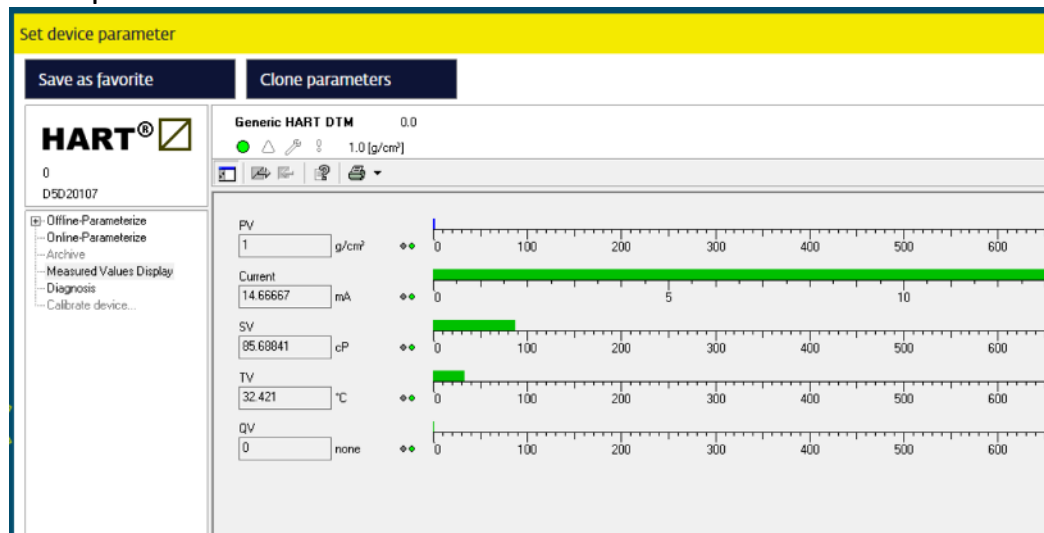

Figure 12. Measured values display.

## 3.4 Device Specific HART commands

The Density SRV output can be described as a polynomial of the form:

$$D_{out} = D_{o5} * T^5 + D_{o4} * T^4 + D_{o3} * T^3 + D_{o2} * T^2 + D_{o1} * T + D_{o0} \quad (1)$$

This model can describe constant density or a temperature-dependent density.

a. Constant density input

To describe a constant density, the coefficient Do0 should be set equal to the constant density value, and all the other coefficients should be set to zero.

b. Temperature-dependent density input

To describe a temperature-dependent density, assign values to the coefficients, that reflect the density behavior of your fluid with temperature. If you have a fluid reference table (for example Cannon fluids, Nippon grease), you can fit the density to a polynomial model to get the coefficients.

All the test below will be completed with HARTmpt software (See Appendix C: HARTmpt software)

3.4.1 Command 128 - Write SRV Density

SRV HART devices can edit these coefficients by using the HART command 128, this can be achieved by inputting the coefficient in hex format.

3.4.2 Define the coefficient values based on a polynomial model, for example

Do0= 1	Do1=0.003	Do2=0.001
--------	-----------	-----------

3.4.3 Convert coefficients to Hex based on section 2.6.1, all unused values must be covered too, otherwise the command will return an error command

Do0= 0x3f800000	Do1=0x3b449ba6	Do2=0x3a83126f
-----------------	----------------	----------------

3.4.4 Input the hex value for all the coefficients 3F 80 00 00 3B 44 9B A6 3A 83 12 6F 00 00 00 00 00 00 00 00 00 00 00

3.4.5 Input data bytes with software like HARTmpt and click send command

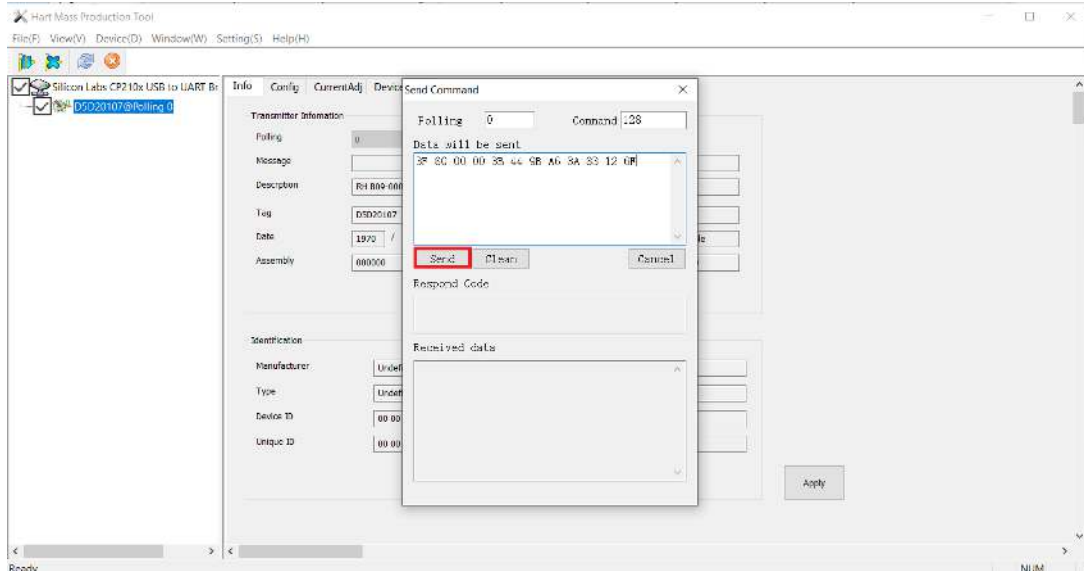

Figure 13. Command 128, write density.

### 3.4.6 Command 128 response, the response is as expected based on Table 2.6.1

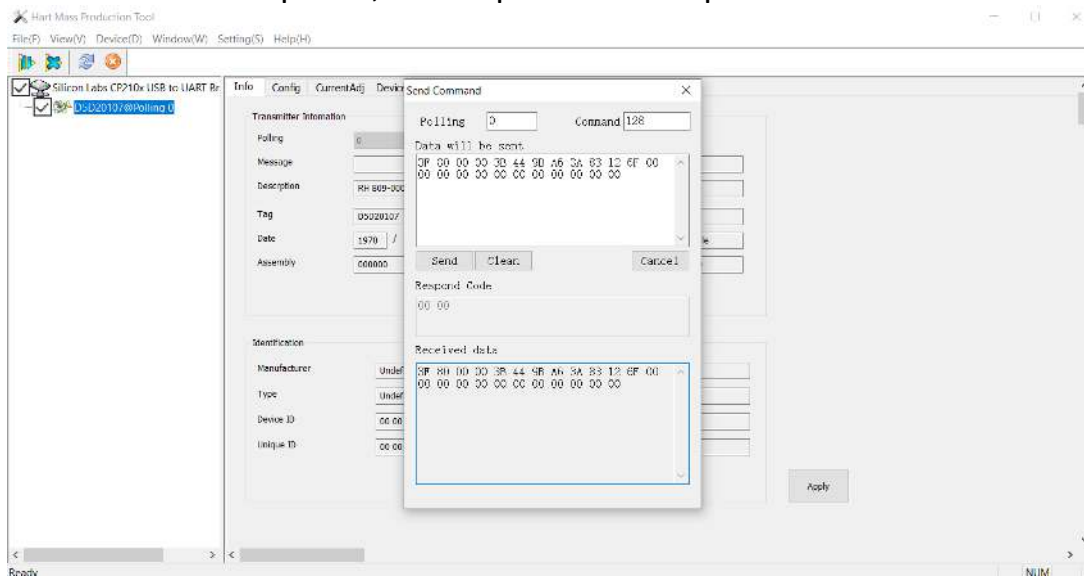

Figure 14. Command 128 response from HARTmpt.

### 3.4.7 Command 129 - Read SRV Density

This command will return the current values from the density model that are loaded into the SRV

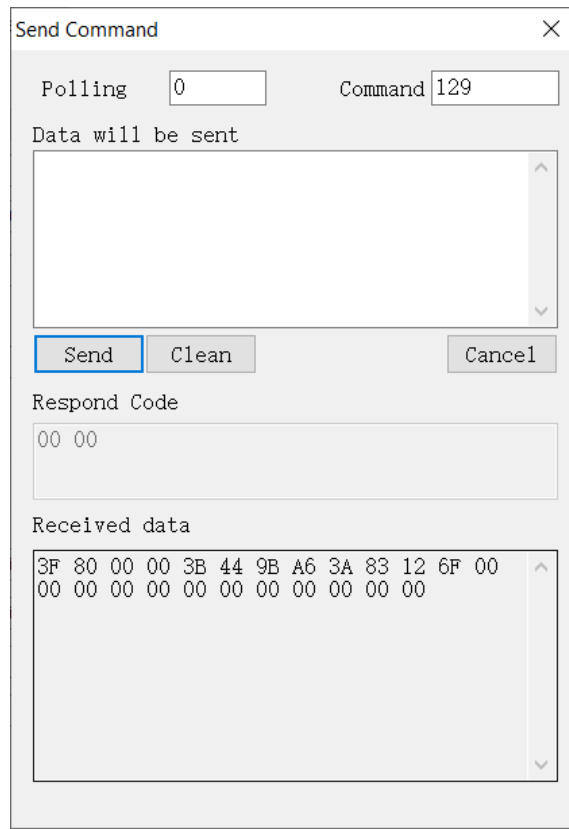

Figure 15. Command 129 response.

### 3.5 Host interface

#### 3.5.1 Analog Output 1: 4-20mA

The HART Communication is supported on an active two-wire 4-to-20mA current loop.

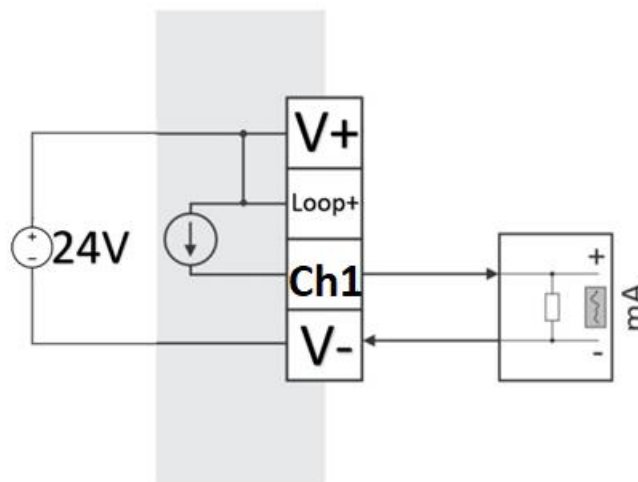

Figure 16. Electrical wiring.

Note: SME 4-20mA outputs are self-powered from SME, so no external power is required to power the 4-20mA channels on the SME.

### 3.6 Wiring Diagram

The SME can produce HART-compatible signals for any HART communicator, this is accomplished with the 4-20mA analog signal that is on channel 1 from the SME. For the connection of the modem or communicator with the HART-board, a resistor of the value  $\sim 250\Omega$  is needed.

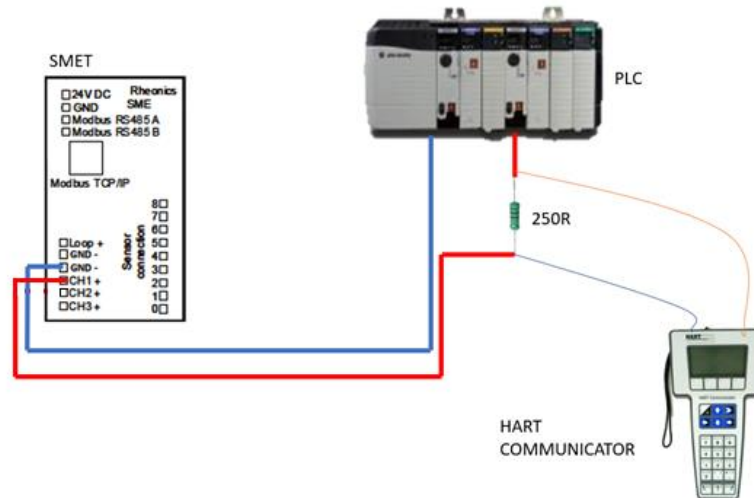

Figure 17. Connection over the network.

### 3.7 Setting the SME with the RCP

RCP is one of our main applications, it is primarily used for monitoring and recording the sensor measurements: Viscosity, density, temperature, and pressure. It is also used to configure the sensor electronics, and the various communication protocols available on the Rheonics sensors.

- 3.7.1 Channel 1 is set to density in SME with a 4-20mA range set to 0 – 1.5g/cc. These limits can be edited but be aware that it sets the primary variable range as well. The primary variable always tracks what is in channel 1

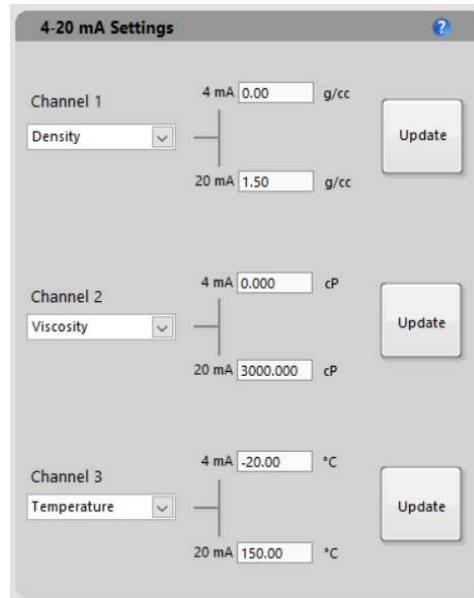

Figure 18. Density parameters in SME.

### 3.8 LCD DISPLAY

The SME-TRD device has the capability to blink the HART led to indicate that it is working correctly. HART LED is in the top right corner of the display.



Figure 19. SME-TRD HART led.

HART LED ON DISPLAY	Meaning
Always OFF	HART disabled
Always GREEN	HART enabled, idle state
Blinking GREEN	Bytes received; command not completed yet
Blinking RED	Bytes received; data corrupted
Always RED	Loop is open, no HART communication possible

Table 3. LED blinking pattern

## 4 Sensor Status

All Rheonics sensors (SRV, SRD, DVP, DVM) for inline viscosity and density monitoring have inbuilt status. Sensor status is always available as the fourth variable

### 4.1 Sensor Error Status

The sensor status can take any of the following values:

Bit	Hex	Name	Comment
Bit 0	0x0001	PLL frequency mismatch	The PLL frequency does not match the sensor frequency. Derived from the ASB string (E10)
Bit 1	0x0002	PLL not locked	The PLL is not locked. Derived from the ASB string (E01)
Bit 2	0x0004	PLL lock incorrect	The PLL has locked on a wrong frequency. Derived from the ASB string (E02)
Bit 3	0x0008	ASB communication error	Issues with sensor electronics
Bit 4	0x0010	Temperature sensor failed	The temperature sensor has failed. Derived from the ASB string if the temperature is -273.0
Bit 5	0x0020	Sensor too hot	If the temperature is above the hardcoded physical temperature limit.
Bit 6	0x0040	ASB communication error	Communication issue between two electronics board in the SME
Bit 7	0x0080	Serial Changed	
Bit 8	0x0100	Status not clean	Sensor is not clean (only SRV)
Bit 9	0x0200	Status in Air	Determines if sensor is in air
Bit 10 -15	Unused		

Table 4. Sensor error status bit code and description.

### 4.2 How to read sensor status?

Sensor status is a WORD data type, these status bits can be used over digital communication channels to understand when the sensor is operating correctly and when there is an issue.



Figure 20. Sensor error status for the Fourth variable.

Sensor error status is the combination of any bit, in this scenario Error 512 is the combination (OR) of the error bits also this decimal value should be converted to its hexadecimal representation, which is “200”, A sensor error status with code 200 means that the sensor is in air.

### 4.3 How to read sensor serial number and sensor type?

The “Description” message showcases the sensor serial number and sensor type, this is achieved through command 13 from HART protocol.

Transmitter Information			
Polling	0		
Message			
Description	RH 809-0001 SRV		
Tag	D5D20107	Alarm Type	High
Date	1970 / 1 / 1	Write Protect	Enable
Assembly	000000	Vendor ID	615D

Figure 21. Sensor serial number and sensor Type



# 5 Troubleshooting

Communication Issues	
No device found	<ol style="list-style-type: none"><li>1. Verify all connections open circuits, shorts, or bad wiring.</li><li>2. Determine if the loop resistance is at least 250 or higher (max 720)</li><li>3. Check the polling address and duplicate address.</li></ol>
Erratic readings	
	<ol style="list-style-type: none"><li>1. Verify SME is properly grounded.</li><li>2. Check external electrical interferences.</li></ol>
Power issues	
	<ol style="list-style-type: none"><li>1. Verify correct power levels are applied to the transmitter.</li><li>2. Verify wiring.</li><li>3. Verify voltage drop.</li></ol>

<a href="https://support.rheonics.com/support/solutions/articles/81000401752-hart-troubleshooting">https://support.rheonics.com/support/solutions/articles/81000401752-hart-troubleshooting</a>	
---	--

- Contact RHEONICS support desk
  - [support@rheonics.com](mailto:support@rheonics.com)
  - <https://support.rheonics.com>

<a href="https://support.rheonics.com/support/home">https://support.rheonics.com/support/home</a>	
---	---

## 6 Appendix C: HART Modem

The SM100 - C is a HART intelligent communicator designed by JIAXING SONGMAO and complied with the industrial standard. It communicates with any manufacturer of HART instruments, such as Rosemount, E + H, Siemens, Cologne, Yokogawa, etc. The appearance is complied with integrated design, enabling to install and carry portably. The communicator is compatible with a standard USB interface and serial bus power supply to ensure convenience and quickness.

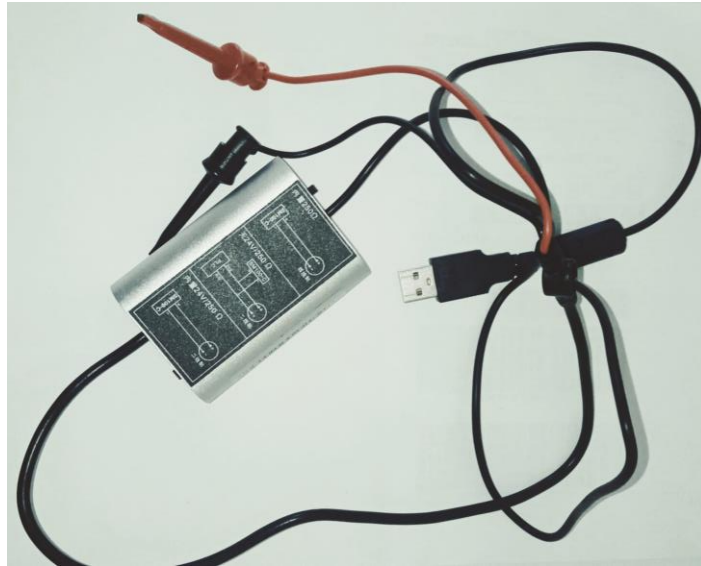

<http://www.hart-rs232.com/>

### DISCLAIMER

Rheonics is not endorsing this product, users should use it at their own risk, and it merely serves for informational and illustration purposes; no rights can be derived from its contents.

## 7 Appendix B: PACTWARE DC software

PACTware is the manufacturer and Fieldbus-independent operating software for all kind of field devices and protocols.

Each PACTware installation can operate all HART devices. The setup includes a communication driver for common HART modems and a generic HART device DTM.

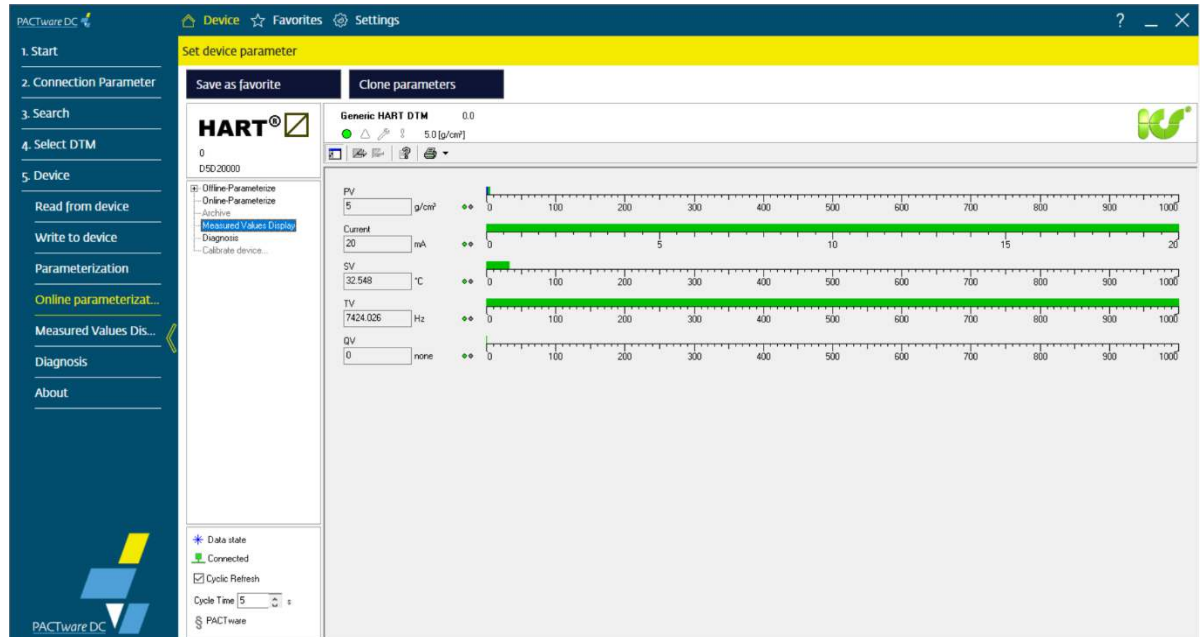

Website: <https://pactware.com/>

Licensing: PACTware is freely available to download, but Only member companies of the PACTware consortium are entitled to offer PACTware for download on their websites.

### DISCLAIMER

Rheonics is not endorsing this product, users should use it at their own risk, and it merely serves for informational and illustration purposes; no rights can be derived from its contents.

## 8 Appendix C: HARTmpt

HARTmpt is a configuration and Universal software for HART devices. This software contains Universal commands for HART already incorporated, but also provides features to send commands by a user.

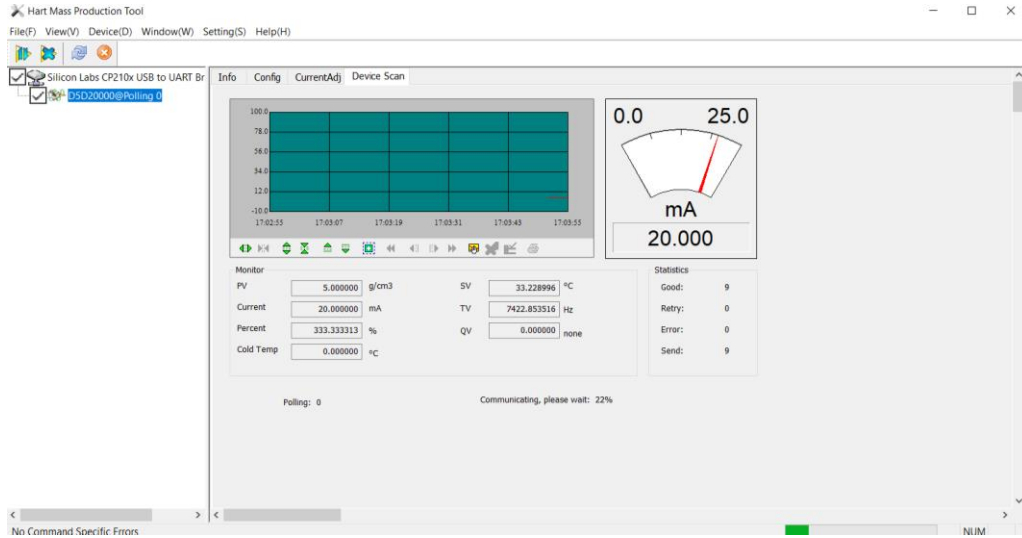

Website: <http://www.microcyber.cn/en/>

Licensing: HARTmpt can be downloaded from the “DOWNLOAD CENTER” from Microcyber under the name “[HART PC Configuration Tool](#)”

### DISCLAIMER

Rheonics is not endorsing this product, users should use it at their own risk, and it merely serves for informational and illustration purposes; no rights can be derived from its contents.

## 9 Notes/Errata

Contact Rheonics support for customization of system settings.

### Notes

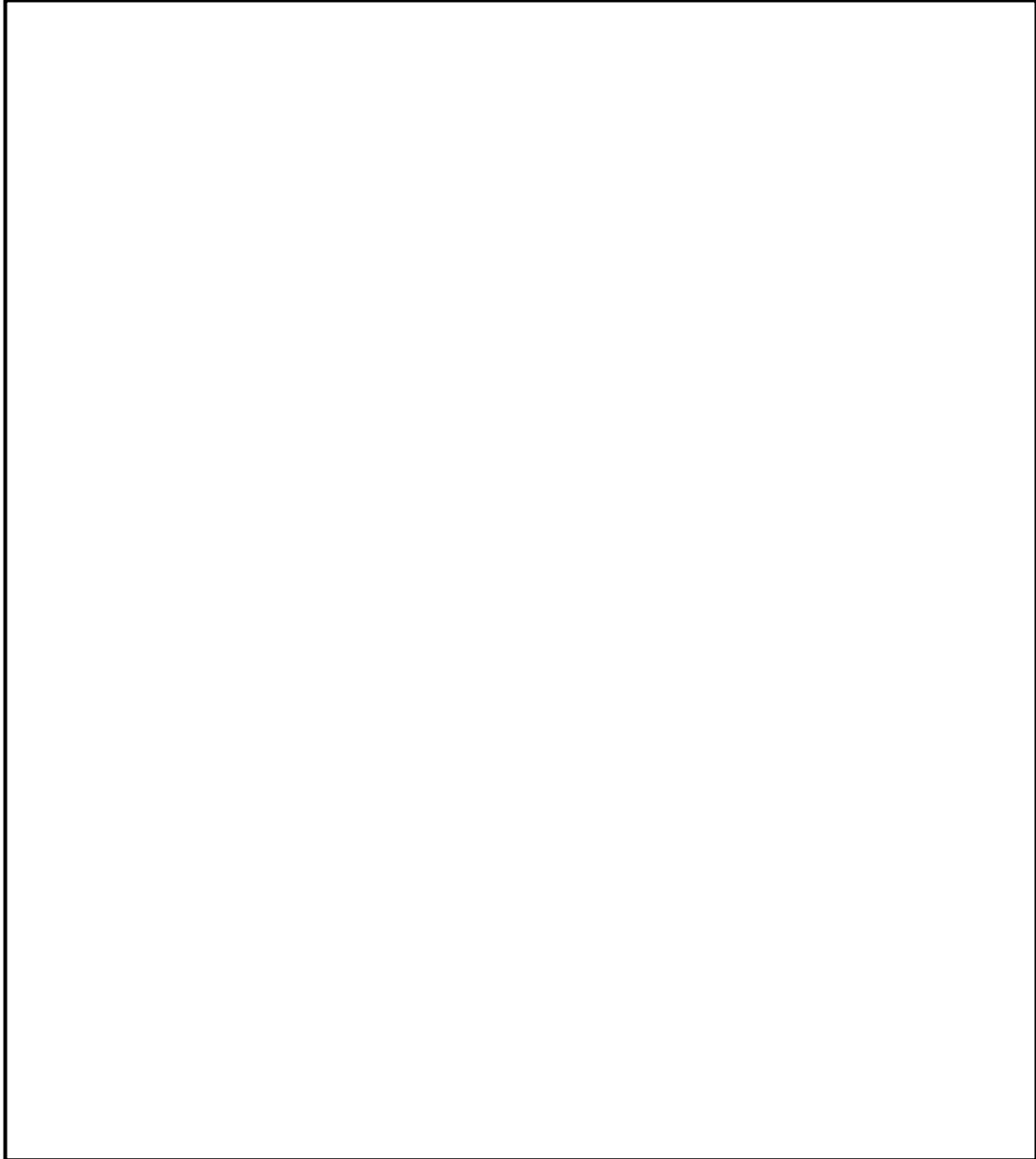

## EUROPE HEADQUARTERS

### Rheonics GmbH

Klosterstrasse. 19  
8406 Winterthur Switzerland  
Tel: +41 52 511 32 00

## US HEADQUARTERS

### Rheonics, Inc.

3 Sugar Creek Center Blvd, Ste 100  
Sugar Land, TX 77478  
United States of America  
Tel: +1 713 364 5427

Website: <https://rheonics.com>  
Support Portal: <https://support.rheonics.com>  
Sales E-Mail: [info@rheonics.com](mailto:info@rheonics.com)  
Support E-Mail: [support@rheonics.com](mailto:support@rheonics.com)

©2022 Rheonics, Inc. All rights reserved.  
The Rheonics logo is a trademark and service mark of Rheonics Inc. Photographs, excerpts, trademarks and logos are not endorsements and are used only for representation under fair use copyright laws. All rights stay with the respective owners.

